



PERFEKT s.c.

CATALOG CATALOGUE 2021/2022





PERFEKT s.c.

Chairs, Stools, Benchs, Desks Chaises scolaires, Tabourets, Bancs, Bureaux

Chair, Chaise BETA
diam. of the tube 25x1,5mm



Chair, Chaise BETA H-60
diam. of the tube 25x1,5mm



Stool, Tabouret FILIP H-45,
diam. of the tube 22x1,5mm



Stool, Tabouret FILIP H-60,
diam. of the tube 22x1,5mm



Stool round ,
Tabouret assise ronde H-45



Stool round H-60
Tabouret avec assise ronde H-60



Every year we produce **60 000** chairs.

Chaque année, nous fabriquons **60 000** chaises.



PERFEKT s.c.

Chair, Chaise PAOLA ,
diam. of the tube 25x1,5mm



Chair, Chaise SYLWIA ,
diam. of the tube 25x1,5mm



Chair, Chaise
CHARLOT



Chair, Chaise CHARLOT 2,
4 legs , 4 pieds



Chair, Chaise SOFIA
diam. of the tube 25x1,5mm



Chair, Chaise SOFIA H-60
diam. of the tube 25x1,5mm



Every year we produce **60 000** chairs.

Chaque année, nous fabriquons **60 000** chaises.



PERFEKT s.c.

Chair, Chaise ADAM
diam. of the tube 32x1,5mm



Chair, Chaise MAREK
tube oval 38x20x1,5mm



Chair, Chaise MARIA
diam. of the tube 25mm



Chair, Chaise MAREK BIS
tube oval 38x20x1,5mm



Chair, Chaise CLAUDIA
tube oval 38x20x1,5mm



Every year we produce **60 000** chairs.

Chaque année, nous fabriquons **60 000** chaises.



PERFEKT s.c.

Bench without backseat , Banc sans dossier
diam. of the tube 25x1,5mm



Bench with backseat, Banc avec dossier
diam. of the tube 25x1,5mm

Metal constructions Structure métallique

RAL 4005	0	RAL 5015	10
RAL 9005	1	RAL 4006	11
RAL 5002	2	RAL 3000	12
RAL 6029	3	RAL 5018	13
RAL 8016	4	RAL 1003	14
RAL 7035	5	RAL 6018	15
RAL 3020	6	RAL 7042	16
RAL 3003	7	RAL 7016	17
RAL 1018	8	RAL 1023	18
RAL 9006	9		

Chair, Chaise SYLWIA with arm., avec accoudoirs,
diam. of the tube 25mm



Desk with cupboard and drawers
Bureau avec caisson, caisson 2 tiroires



Every year we produce **10 000** different furniture.
Chaque année, nous fabriquons **10 000** meubles divers.



P E R F E K T s.c.

School, Preschool and Social Tables Tables maternelles et scolaires

School, Preschool and Social Tables

(height 1- 7)

PN – EN 1729 – 1:2007

Tables maternelles et scolaires

(H - taille 1- 7)

PN – EN 1729 – 1:2007

Tables **WERA** , diam. of the tube 40mm or
square 30x30mm



Type of the tops. types de plateaux :



square
carré



rectangulare
rectangulaire



trapezoidal
trapéze

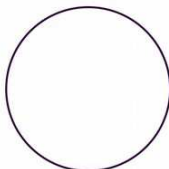

circle , ronde

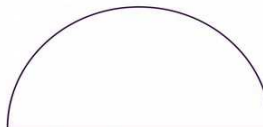

1/2 circle , 1/2 ronde



PERFEKT s.c.

School Tables Tables scolaires

Table ALAN 70x50cm and 130x50cm,
diam. of the tube 32x1,5mm



Table MP 70x50cm and 130x50cm,
tube 40x30x1,5mm

Table MARA 70x50cm and 130x50cm,
diam. of the tube 45/40x1,5mm



Every year we produce **10 000** tables.

Chaque année, nous fabriquons **10 000** tables.



Metal constructions Structure métallique

painting powder according to RAL
peinture epoxy au choix palette RAL

Tops of the tables : Plateaux :

- 1/ melamine thickness 18mm, edge ABS 2mm
mélamine ép. 18mm, chants ABS 2mm
- 2/ melamine thickness 18mm, edge rounded, profile „T”
mélamine ép. 18mm, chants arrondis
- 3a/ MDF / HPL, edge rounded
MDF / HPL stratifié, chants arrondis
- 3b/ MDF /LAM, edge rounded
MDF /LAM chants arrondis

Construction colour options EXEMPLES

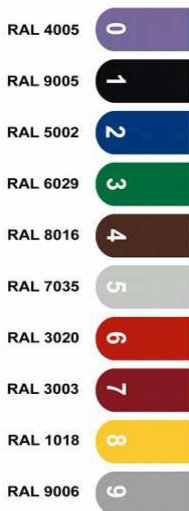

beech, hêtre alder, aulne grey, gris clair



maple, érable cream, crème





PERFEKT s.c.





PERFEKT s.c.

MOULDED PLYWOOD, PIÈCES MOULÉES

Exemples moulded plywood

Exemple garnitures pour les chaises



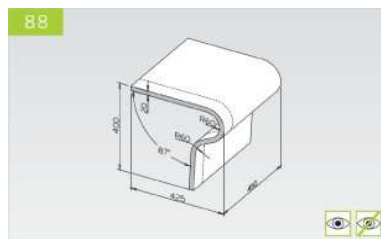
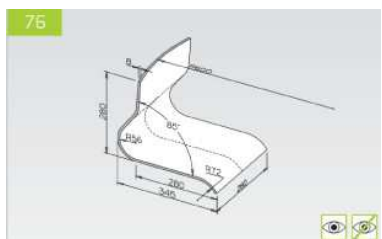
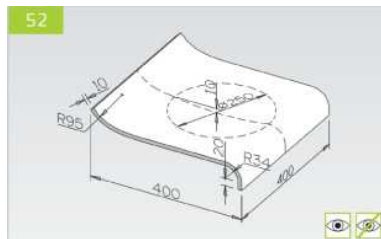
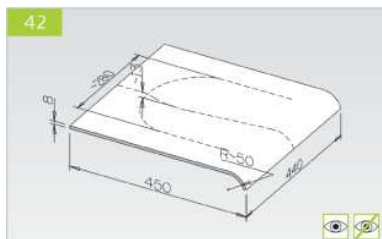
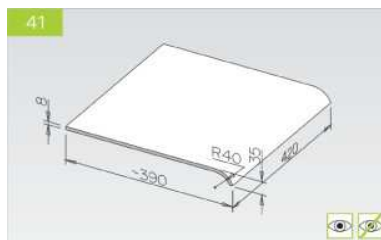
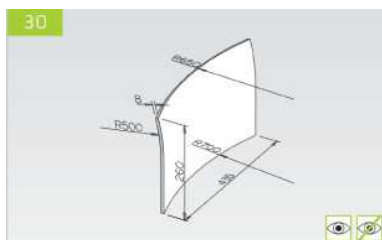
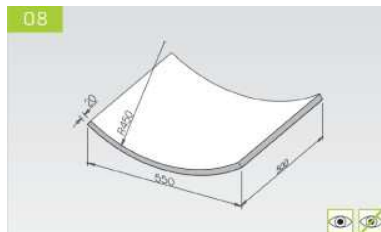
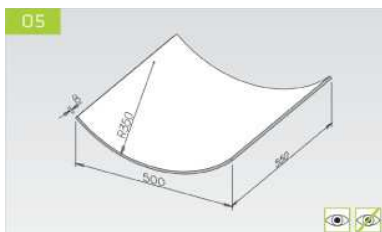

Examples moulded plywood for chairs, Exemple assises et dossiers de chaises

seat gross format , assise brute

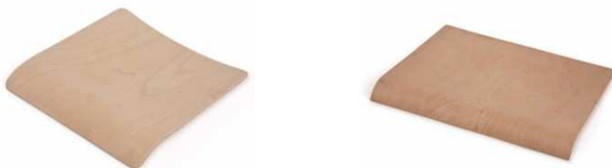

final seat produced using CNC machines, assise fabriqué par CNC

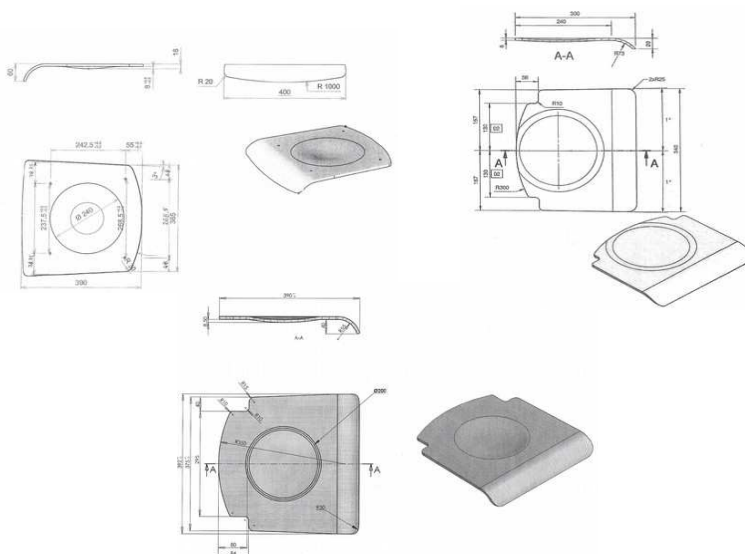

final seat produced using CNC machines, varnished
assise fabriqué par CNC, verni





PERFEKT s.c.

back gross format, dossier brute



final back produced using CNC machines,
dossier fabriqué par CNC

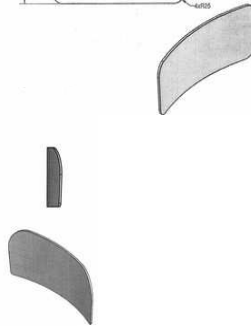
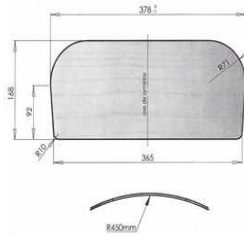
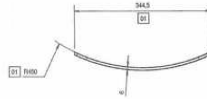
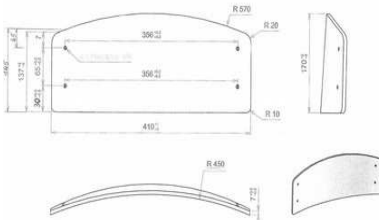

final back produced using CNC machines, varnished
dossier fabriqué par CNC, verni





PERFEKT s.c.

seat with back – one piece chair, gross format
coque brutes



seat with back – one piece chair, produced using CNC machines
coque brutes fabriqué par CNC

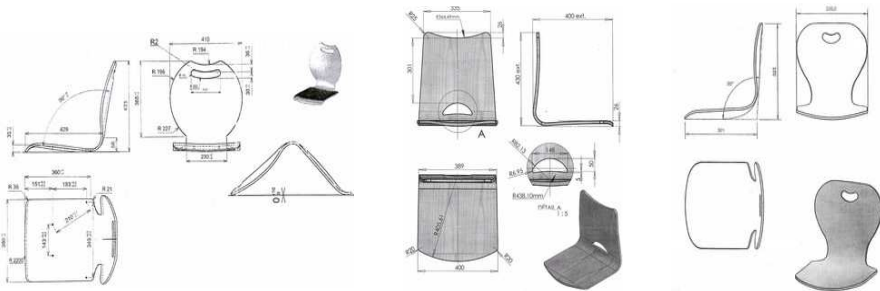

seat with back – one piece chair, produced using CNC machines, varnished
coque brutes fabriqué par CNC, verni





PERFEKT S.C.

Packed on pallets, conditionné sur palettes

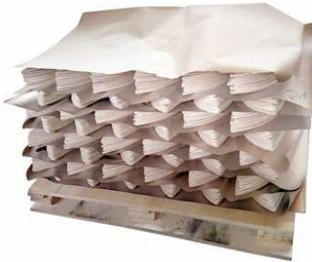

Our mission is to provide a first class choice of quality school furniture for education establishments. We give you over 20 years of experience in manufacturing school equipment, short terms of delivery and highest quality furniture made in accordance with Europeans standards. Our catalogue includes children's school furniture, classroom chairs, seating, school desks and tables, school lockers, school bookcases and storage, presentation and staging equipment and residential furniture for every room in your establishment.

We invite you to visit our website to see the full range of products that we offer.

Nous avons le plaisir de vous présenter notre société qui est Polonaise et au sein de laquelle nous fabriquons tout une gamme de produits tel que: mobilier scolaire, maternelle, bureautique, armoires métalliques, sieges amphitheatre, composants pour les chaises.

Tous nos produits possèdent les certificats nécessaires a savoir: normes européennes, bois certifié PEFC, production sous ISO 14001 et notre équipement est de haute qualité: (le choix de matieres premieres, des finitions en poudre époxy cuite au four..)

Notre statut de fabricant, nous confere la possibilité de fabriquer notre mobilier aux mesures de nos clients. Nos délais de fabrication sont tres rapides.

Contact us :

PERFEKT S.C.
www.perfektsc.com.pl

tel.: +48 58 685 44 48 +48 58 685 44 49

fax: +48 58 681 11 87

e-mail: biuro@perfektsc.com.pl
perfektsc@perfektsc.com.pl



PERFEKT S.C.